

● Features:

1. Chip material: AlInGaN
2. Emitted color : Super Blue
3. Lens Appearance : Water Clear
4. Low power consumption.
5. High efficiency.
6. Versatile mounting on P.C. Board or panel.
7. Low current requirement.
8. 5mm diameter package
9. This product don't contained restriction substance, compliance ROHS standard.

● Applications:

1. TV set
2. Monitor
3. Telephone
4. Computer
5. Circuit board

● Package dimensions:

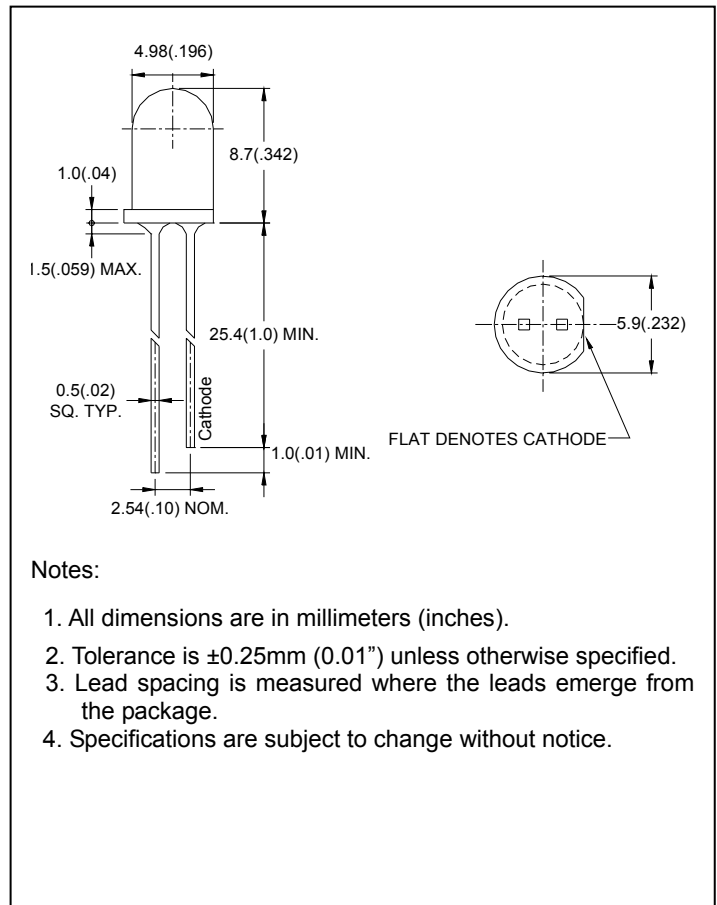

● Absolute Maximum Ratings(Ta=25°C)

Parameter	Symbol	Rating	Unit
Power Dissipation	Pd	120	mW
Forward Current	I _F	30	mA
Peak Forward Current* ¹	I _{FP}	150	mA
Reverse Voltage	V _R	5	V
Operating Temperature	Topr	-40°C~80°C	
Storage Temperature	Tstg	-40°C~85°C	
Soldering Temperature	Tsol	260°C (for 5 seconds)	

*¹Condition for I_{FP} is pulse of 1/10 duty and 0.1msec width.

● Electrical and optical characteristics(Ta=25°C)

Parameter	Symbol	Condition	Min.	Typ.	Max.	Unit
Forward Voltage	V_F	$I_F=10\text{mA}$	-	3.5	4.0	V
Luminous Intensity	I_v	$I_F=10\text{mA}$	-	1100	-	mcd
Reverse Current	I_R	$V_R=5\text{V}$	-	-	100	μA
Peak Wave Length	λ_p	$I_F=20\text{mA}$	-	470	-	nm
Dominant Wave Length	λ_d	$I_F=20\text{mA}$	460	-	475	nm
Spectral Line Half-width	$\Delta\lambda$	$I_F=20\text{mA}$	-	30	-	nm
Viewing Angle	$2\theta_{1/2}$	$I_F=20\text{mA}$	-	50	-	deg

● Typical electro-optical characteristics curves

Fig.1 Relative intensity vs. Wavelength

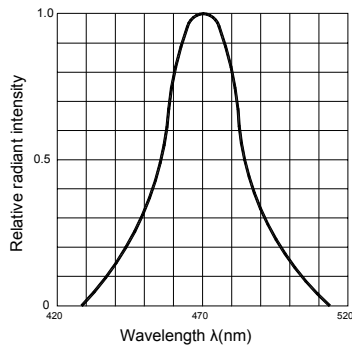

Fig.2 Forward current derating curve vs. Ambient temperature

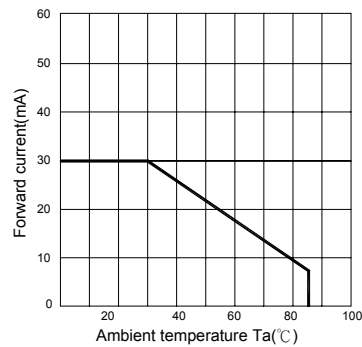

Fig.3 Forward current vs. Forward voltage

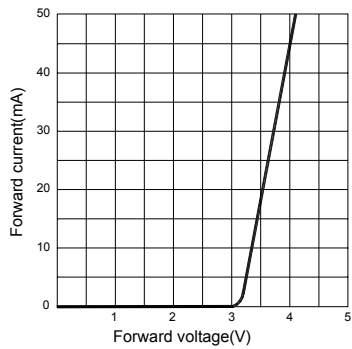

Fig.4 Relative luminous intensity vs. Ambient temperature

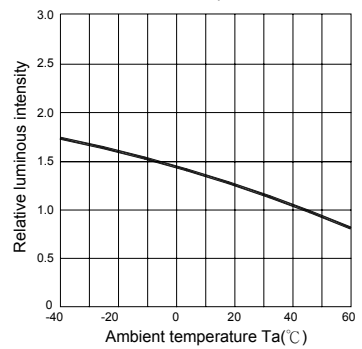

Fig.5 Relative luminous intensity vs. Forward current

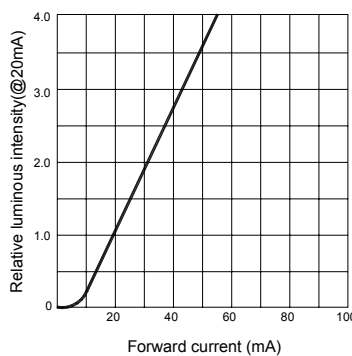
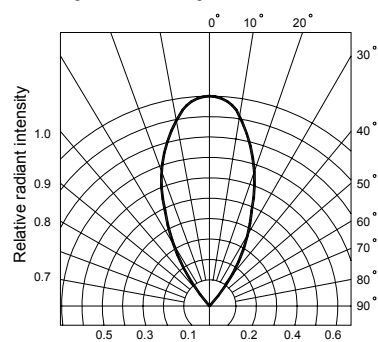

Fig.6 Radiation diagram



● **Bin Limits**

1. Intensity bin limits (At $I_F=20\text{mA}$)

Bin Code	Min. (mcd)	Max. (mcd)
:	:	:
U	410	820
V	620	1230
W	930	1840
X	1390	2760
Y	2090	4260
:	:	:

2. Color Bin Limits (At $I_F=20\text{mA}$) : Dominant Wave Length $\lambda_d(\text{nm})$

Bin Code	Min. (nm)	Max. (nm)
3	459	466
4	464	471
5	469	476

